

1 Listen and look at the pictures. Circle A, B, or C.  01

Example

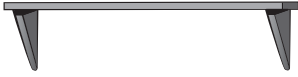

(A)

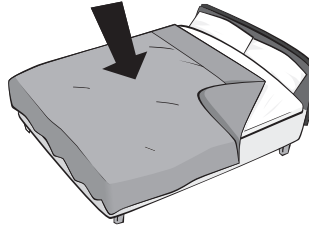

(B)

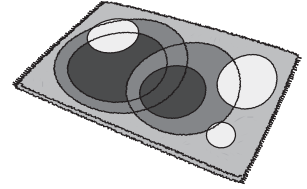

(C)

1

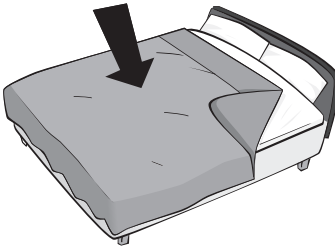

(A)



(B)

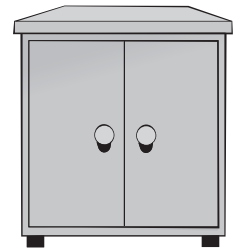

(C)

2

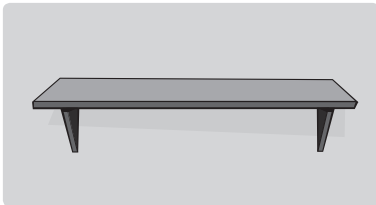

(A)

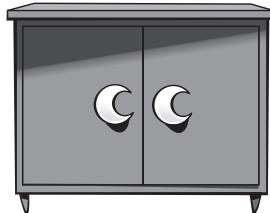

(B)

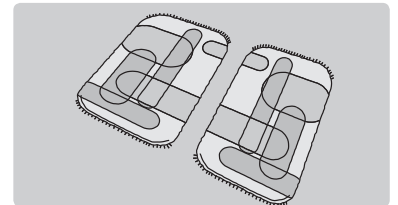

(C)

3



(A)

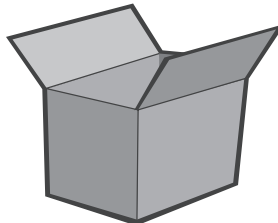

(B)

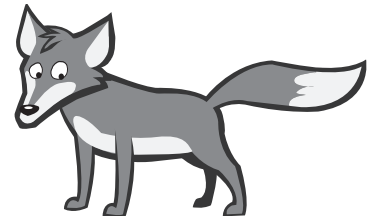

(C)

2 Listen. Which sentence or conversation sounds correct? Circle A, B or C. 02

Example

(A)

 (B)

(C)

1

(A)

(B)

(C)

2

(A)

(B)

(C)

3

(A)

(B)

(C)

3 Listen and read. Circle A, B, or C. 03

Example

 (A)

Anh lives in an apartment.

(B)

Anh lives in a house.

(C)

Anh lives in a school.

1

(A) Anh's sister is in the bedroom.

(B) Anh's mom is in the kitchen.

(C) Anh's sister is in the living room.

2

(A) Anh likes books.

(B) Anh has six books.

(C) Anh's favorite book is red.

3

(A) Anh's favorite toy is a teddy bear.

(B) Anh's favorite toy is a doll.

(C) Anh's favorite toy is a train.

4 Listen and draw. 🎧 04

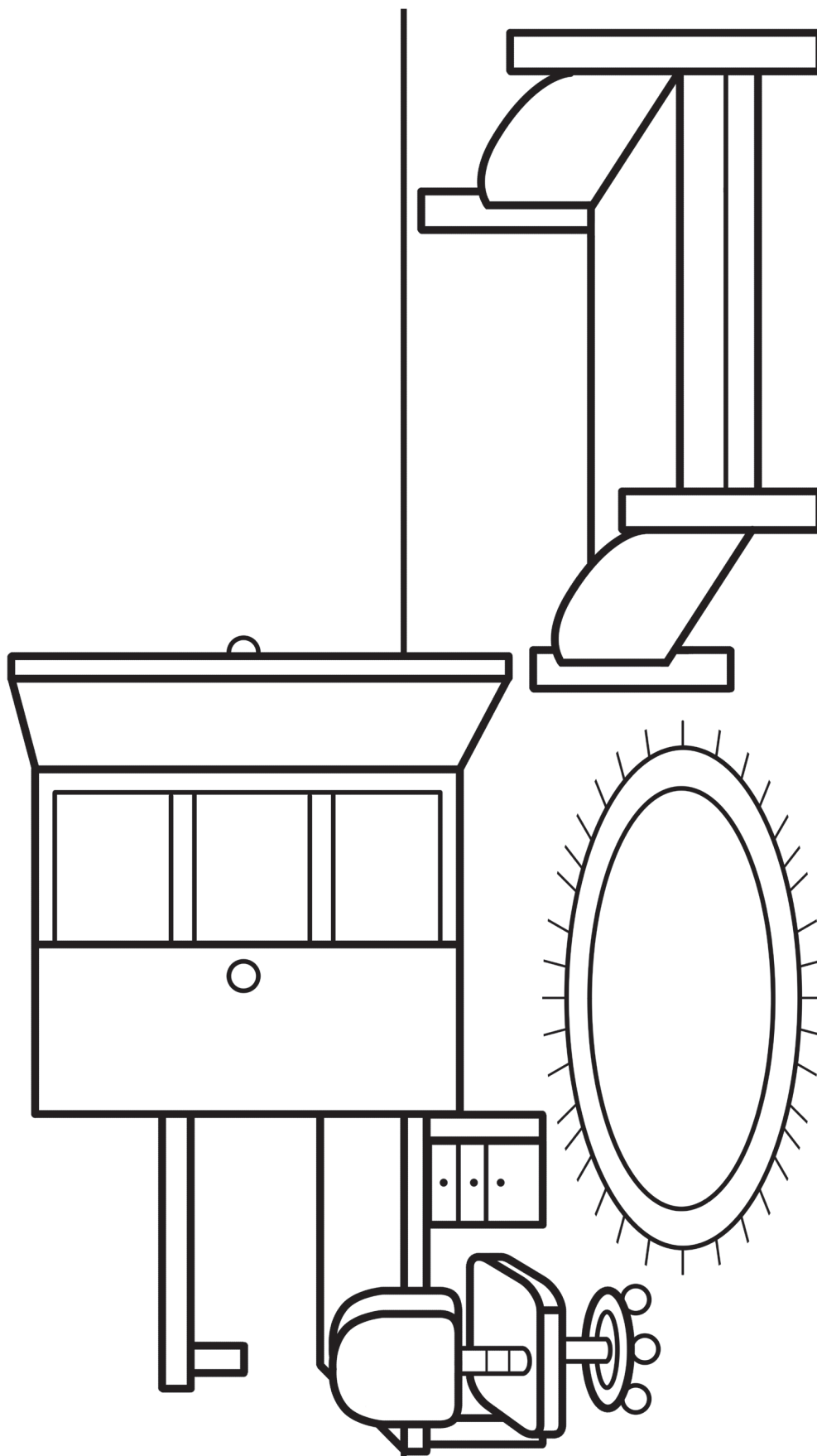

1 Look and circle. Write.

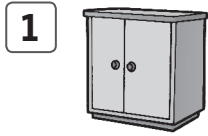

cabinet

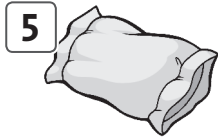
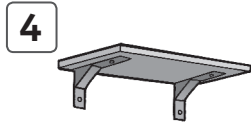

e	i	g	h	t	e	e	n	★	f
c	a	b	i	n	e	t	★	★	i
★	★	★	★	★	★	★	★	s	f
★	t	w	e	l	v	e	★	h	t
★	★	★	★	★	★	★	★	e	e
★	★	p	i	l	l	o	w	l	e
★	★	★	★	★	★	★	★	f	n

2 Look and write.



1 There's a ball under my bed.

2 _____ a train _____ my cabinet.

3 _____ a teddy bear _____ my _____.

4 _____ dolls _____ my rug.

1 Look. Circle the mess in each room.

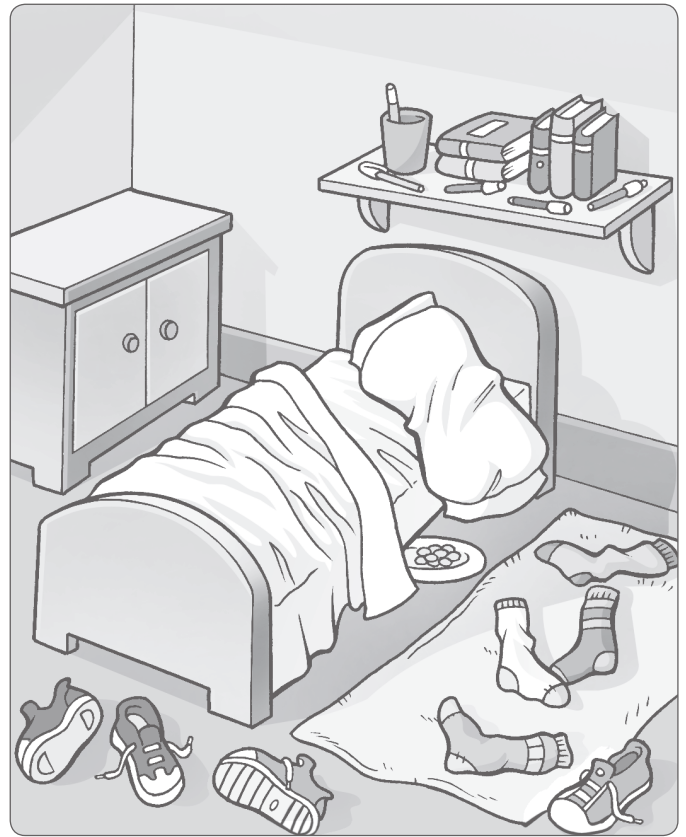

2 Read and draw.

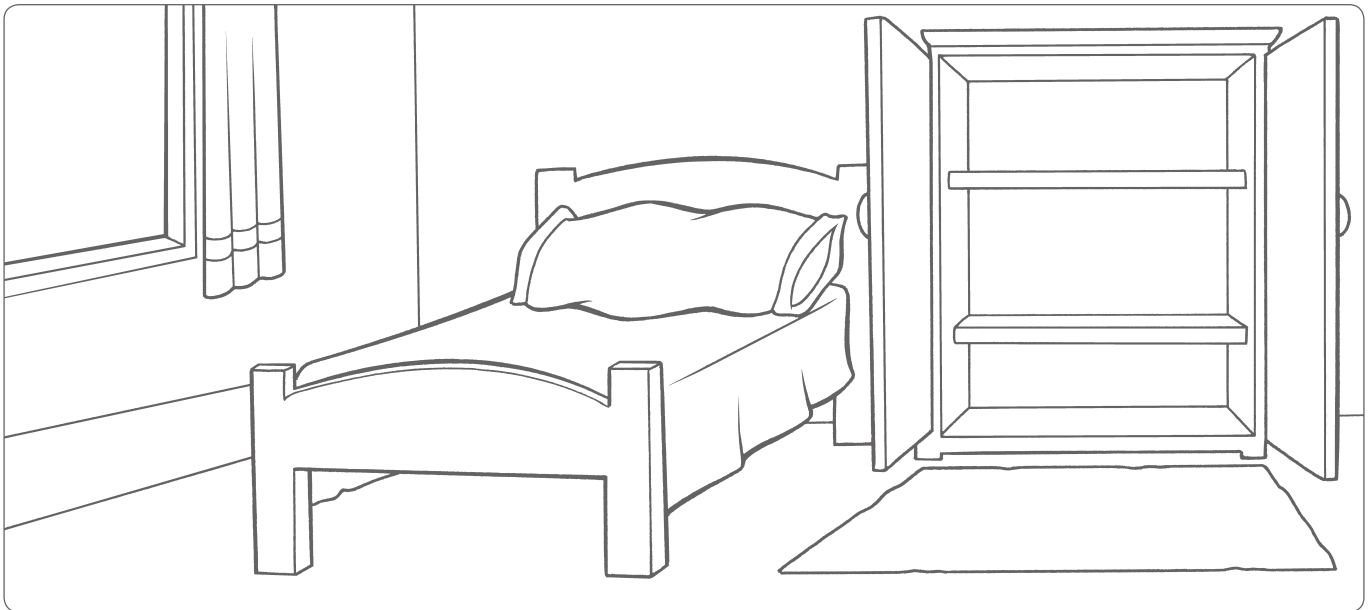

There's a teddy bear on the bed.
There's a ball in the cabinet.

There's a train under the bed.
There are some cars in the cabinet.

1 Complete the words.

/4

1

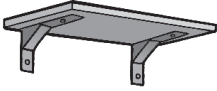

shelf

2



blanket

3



pillw

4



rug

5

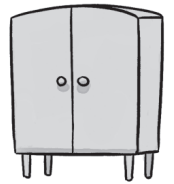

cabnet

2 Write the correct words and numbers.

/4

- 1 svenetnee seventeen
- 2 wtleve _____
- 3 teenffi _____
- 4 entytw _____
- 5 fteenour _____

3 Complete the sentences with *in*, *on*, or *under*.

/3

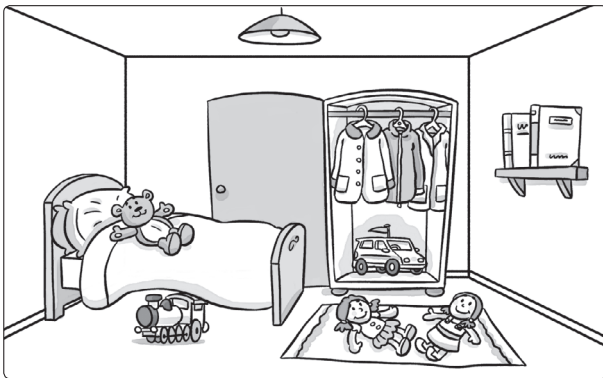

- 1 The books are on the shelf.
- 2 The train is _____ the bed.
- 3 The dolls are _____ the rug.
- 4 The coats are _____ the cabinet.

4 Complete the sentences.

/4

- 1 There's a train under the bed.
- 2 _____ teddy bear _____ the bed.
- 3 _____ three coats _____ the cabinet.
- 4 _____ two books _____ the shelf.
- 5 _____ car _____ the cabinet.

____ /15